

ONLINE LEARNING TRAINING SHARING OF BEST PRACTICES



**17/04/2020
FRIDAY**

Teaching Engineering Drawing Online

10.00am - 11.00am

 <https://zoom.us/j/99026181488>



Dr. Mohd Safarin Nordin
FSK UTM



**Web conferencing
via ZOOM**

For complaint related to online learning services, please contact: olc@utm.my

For students helpdesk, please contact: utmlead@utm.my

For lecturers helpdesk, please contact:
IT manager of your own school/faculty

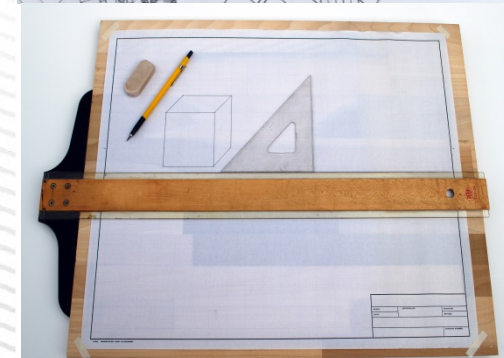
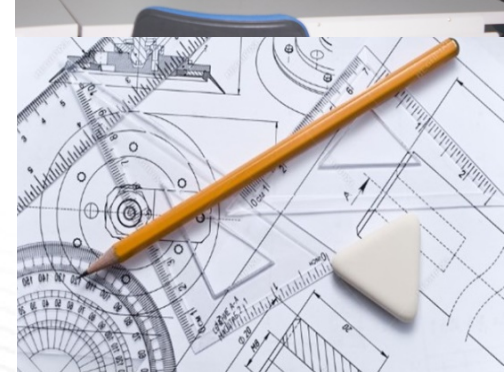

www.utm.my

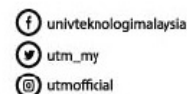

Before Teaching/Class

- CI/CO/Lesson Plan
- Knowledge Preparation
- Material Preparation
- Tools Preparation
- Space Preparation
- Skills Preparation

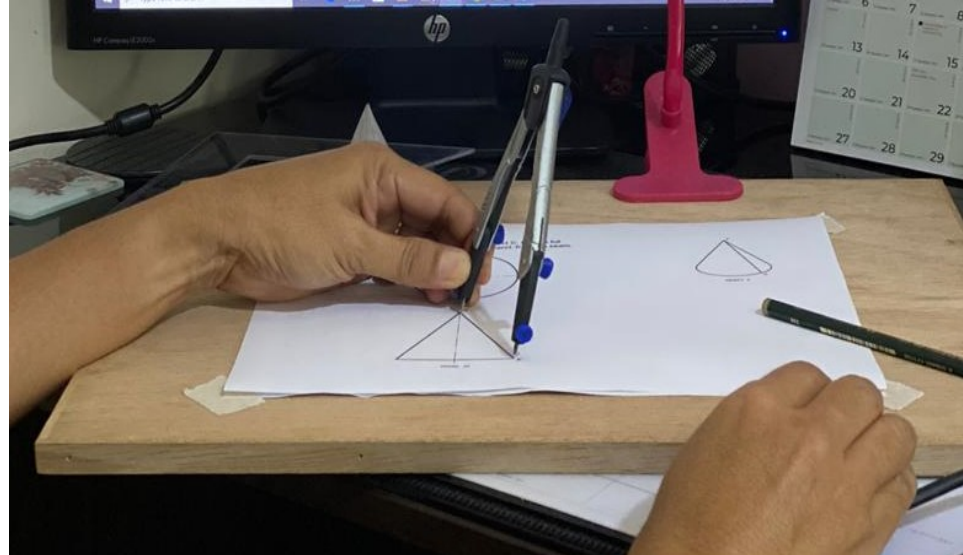

In terms of Online

- Additional knowledge - software/apps.



Webex Meetings

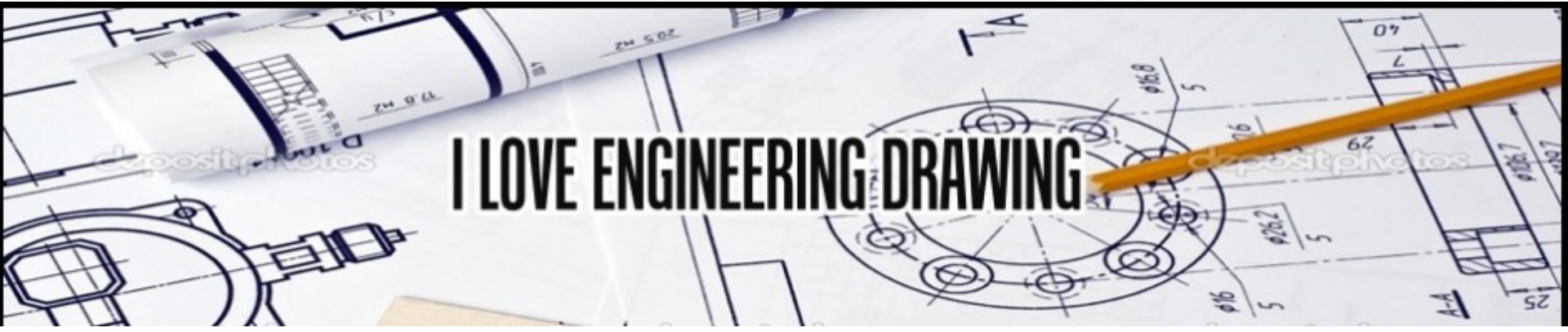

Scheduling Class Meeting

The screenshot displays a Google Calendar interface with a meeting schedule for 'SHPE1022 Development Drawing' on Sunday, April 5. The calendar shows three parts of the meeting:

- SHPE1022 Development Drawing Part 1:** Sunday, April 5 - 2:30 - 3:00pm
- SHPE1022 Development Drawing Part 2:** Sunday, April 5 - 3:10 - 3:40pm
- SHPE1022 Development Drawing Part 3:** Sunday, April 5 - 3:50 - 4:20pm

Overlaid on the calendar are three detailed meeting invitation windows for each part. The third window (Part 3) provides the following details:

- Zoom Link:** <https://zoom.us/j/839020962?pwd=VDk1TFdQQ2pO...>
- Join Hangouts Meet:** <meet.google.com/vvu-city-emj>
- Join by phone:** +1 937-754-5877 PIN: 611 828 139#
- Guests:** 2 guests (1 yes, 1 awaiting)
- Organizer:** p-safarin@utm.my
- Participant:** safarin nordin
- Message:** Mohd Nordin is inviting you to a scheduled Zoom meeting.
- Zoom Meeting Link:** <https://zoom.us/j/839020962?pwd=VDk1TFdQQ2pOOWVJLei9YeDRXY0xidz09>

The calendar interface also shows a 'Meet with...' section with a search bar and 'My calendars' including MOHD SAFARIN BIN NO..., Birthdays, Reminders, SPPR SPACE JB SPACE JB, and Tasks. The system tray at the bottom shows the time as 9:19 AM and the application 'Autodesk Application Manager' is running.

Setup & Testing



Link smartphone & computer

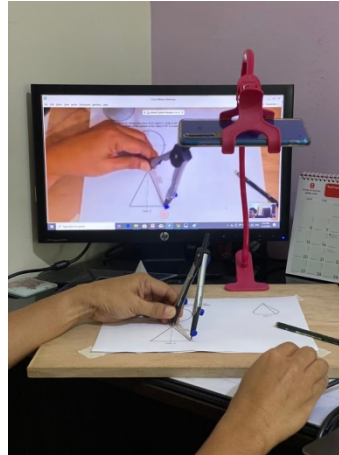

Light brightness test

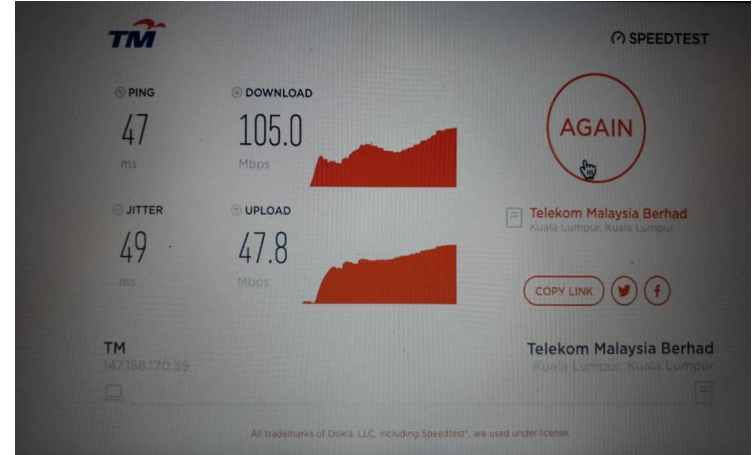

Internet Speed test & Coverage

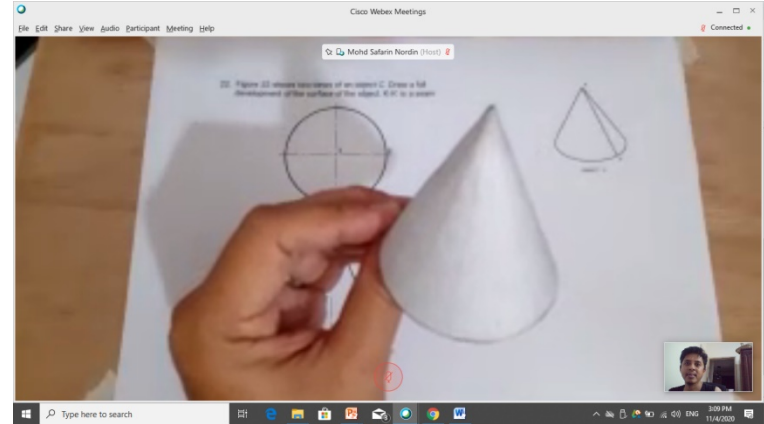
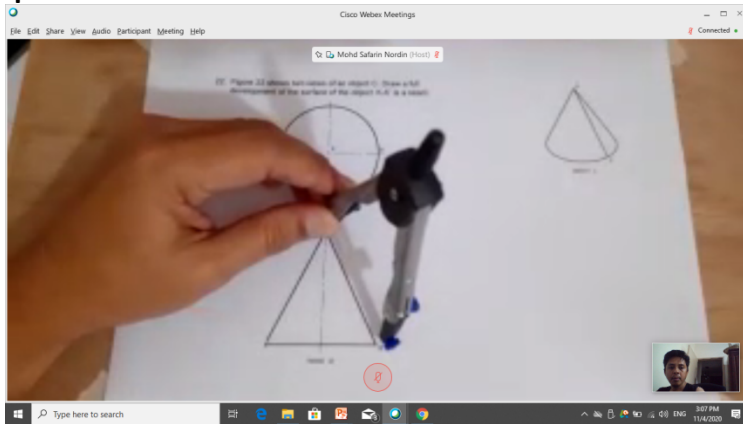

Pre-Online Class/Meeting

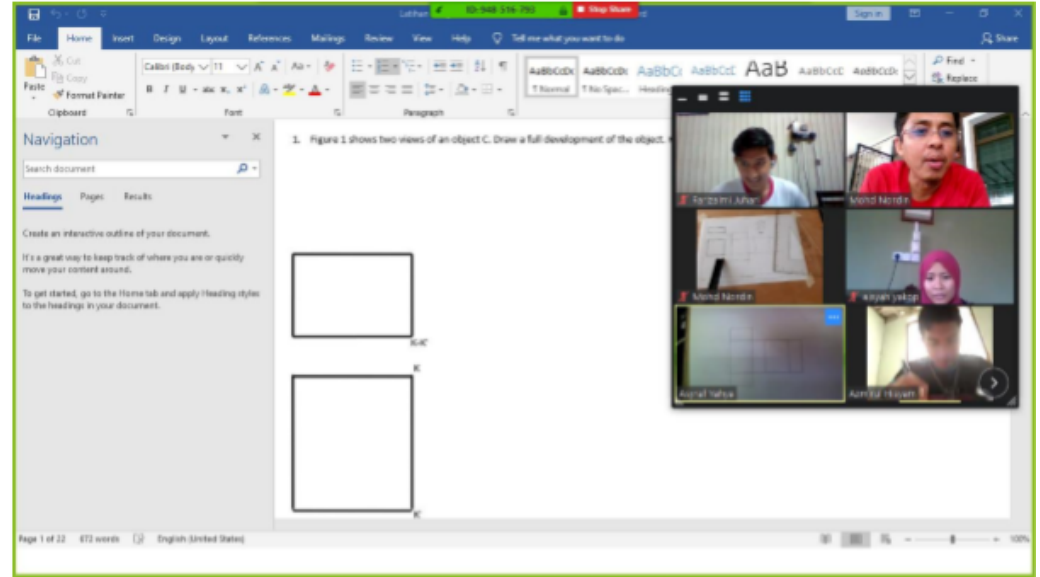

- Test
 - teaching material/presentation
 - students learning

Tool Required

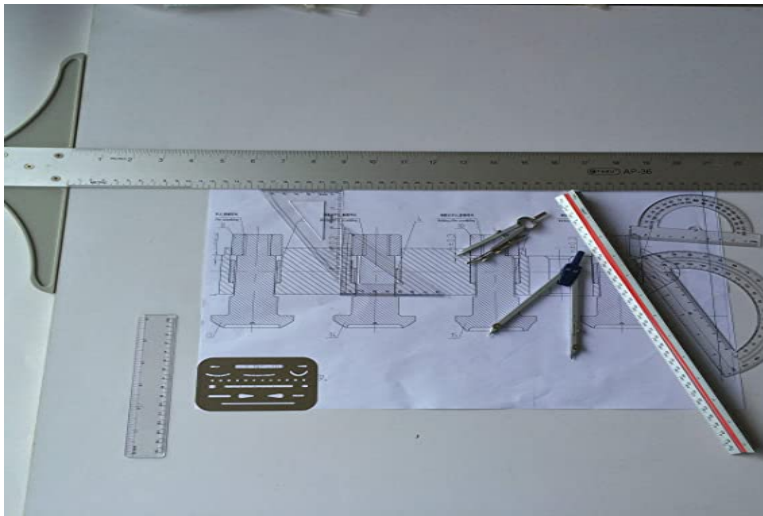

How to setup your computer & smartphone?

1. Sign in your Zoom application.

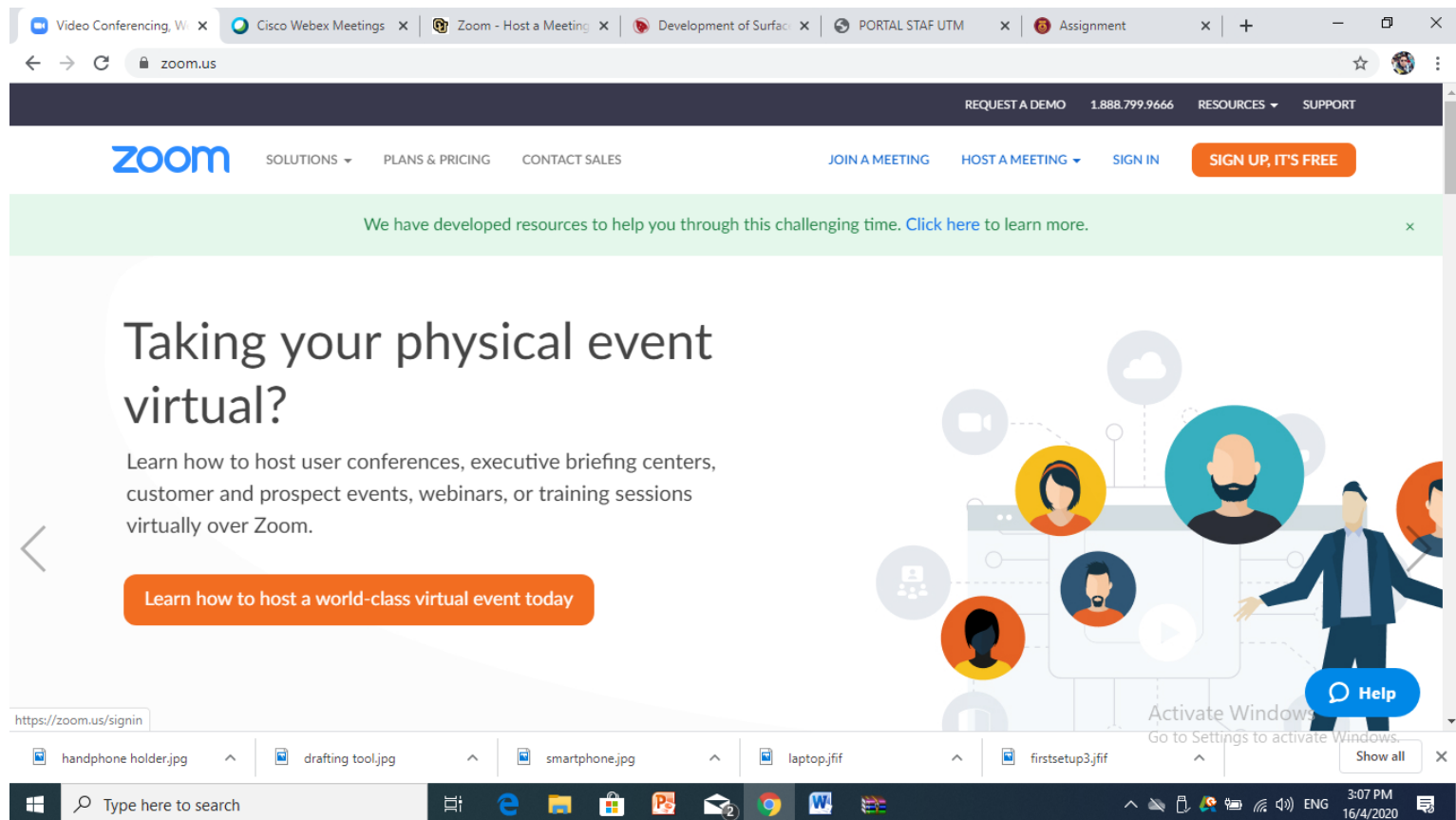

The screenshot shows a web browser window with the Zoom website. The address bar displays 'zoom.us'. The page features a dark navigation bar with links for 'REQUEST A DEMO', '1.888.799.9666', 'RESOURCES', and 'SUPPORT'. Below this is a white navigation bar with the Zoom logo and links for 'SOLUTIONS', 'PLANS & PRICING', 'CONTACT SALES', 'JOIN A MEETING', 'HOST A MEETING', 'SIGN IN', and a prominent orange 'SIGN UP, IT'S FREE' button. A green banner below the navigation bar reads: 'We have developed resources to help you through this challenging time. [Click here](#) to learn more.' The main content area has a large heading 'Taking your physical event virtual?' followed by the text: 'Learn how to host user conferences, executive briefing centers, customer and prospect events, webinars, or training sessions virtually over Zoom.' An orange button below this text says 'Learn how to host a world-class virtual event today'. The background of the main content area features an illustration of a man in a suit pointing at a screen displaying several circular icons representing different users. At the bottom of the browser window, the Windows taskbar is visible, showing the search bar and several application icons. The system tray in the bottom right corner shows the time as 3:07 PM on 16/4/2020 and the language set to ENG.

2. Host a meeting either with **With video Off** or **With video On** or **Screen Share Only** menu.

The screenshot shows the Zoom web interface. The browser address bar displays the URL: `zoom.us/meeting?_x_zm_rtaid=gF0lgnByS5SD_drK_IWmLw.1587021019947.da98a4b15a3c3f7583fea7eb946f8414&_x_zm_rhtaid=275`. The Zoom logo and navigation links (SOLUTIONS, PLANS & PRICING, CONTACT SALES, SCHEDULE A MEETING, JOIN A MEETING, HOST A MEETING) are visible. A dropdown menu is open under 'HOST A MEETING', showing three options: 'With Video Off', 'With Video On', and 'Screen Share Only'. The 'With Video Off' option is highlighted. The main content area shows 'Upcoming Meetings' with a table of scheduled meetings. The Windows taskbar at the bottom shows the system tray with the time 3:11 PM and date 16/4/2020.

zoom.us/meeting?_x_zm_rtaid=gF0lgnByS5SD_drK_IWmLw.1587021019947.da98a4b15a3c3f7583fea7eb946f8414&_x_zm_rhtaid=275

zoom SOLUTIONS PLANS & PRICING CONTACT SALES SCHEDULE A MEETING JOIN A MEETING HOST A MEETING

New Features Our latest release went live on April 12th. Please subscribe to our [blog](#) and visit our [release notes](#) to stay up-to-date on all the latest enhancements to your account. For more information on the latest version of Zoom, visit our [download](#) page.

PERSONAL

- Profile
- Meetings
- Webinars
- Recordings
- Settings

ADMIN

- > User Management

Upcoming Meetings Previous Meetings Personal Meeting Room Meeting Templates Get Training

Schedule a New Meeting Recently Deleted

Start Time	Topic	Meeting ID	
Sun, Apr 19 02:30 PM	SHPE1022 Sectioning Drawing - Concept & Methods of Section	969-9191-9697	Start Delete
Sun, Apr 19 04:00 PM	SHPE1022 Sectional Drawing - Demo 2 Half & Broken Out Section	995-4466-6702	Start Delete

Handphone holder.jpg drafting tool.jpg smartphone.jpg laptop.jiff firstsetup3.jiff

Type here to search

3:11 PM 16/4/2020

3. Use the **Invitation URL** or **Participant ID** to invite yourself in Zoom Apps in your Smartphone

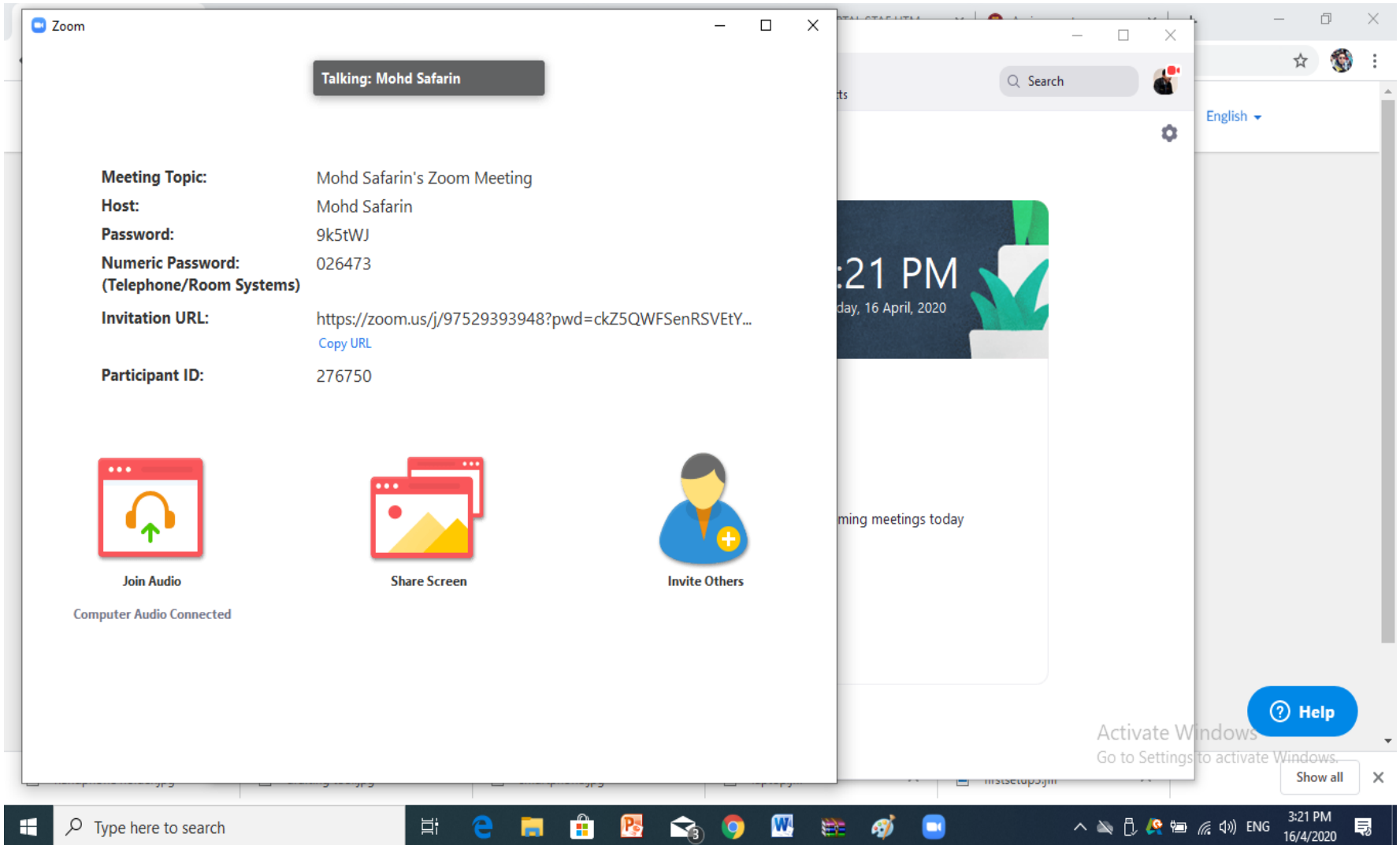

The screenshot displays the Zoom desktop application interface. At the top, it says "Talking: Mohd Safarin". Below this, the meeting details are listed:

- Meeting Topic:** Mohd Safarin's Zoom Meeting
- Host:** Mohd Safarin
- Password:** 9k5tWJ
- Numeric Password: (Telephone/Room Systems):** 026473
- Invitation URL:** <https://zoom.us/j/97529393948?pwd=ckZ5QWFSenRSVEtY...>
[Copy URL](#)
- Participant ID:** 276750

Below the details are three main action buttons:

- Join Audio:** Represented by a red icon with headphones and a green arrow pointing up. Below it, it says "Computer Audio Connected".
- Share Screen:** Represented by a red icon with a yellow mountain range.
- Invite Others:** Represented by a blue icon of a person with a yellow plus sign.

In the background, a browser window is visible showing a search bar, a language dropdown set to "English", and a large digital clock displaying "3:21 PM" with the date "Monday, 16 April, 2020". At the bottom of the screen, the Windows taskbar is visible with various application icons and a system tray showing the time "3:21 PM" and date "16/4/2020".

From computer (Host)

The image shows a Zoom meeting window. On the right side, there is a 'Participants (2)' list. The first entry is 'Safarin (Host, me)' and the second is 'Mohd Nordin'. A red box highlights the 'Safarin (Host, me)' entry, with a red arrow pointing upwards to the text 'From computer (Host)'. A blue dashed box surrounds the 'Mohd Nordin' entry, with a blue arrow pointing downwards to the text 'Join thru smartphone'. The main meeting area shows two video thumbnails: one for 'Mohd Nordin' (with the caption 'Mohd Nordin is connecting to audio ...') and one for 'Safarin' (which is currently black). The Windows taskbar is visible at the bottom, showing the search bar and various application icons. A Windows watermark is present in the bottom right corner.

Join thru smartphone

4. Click your participants which **Join thru smartphone** until More button appear.



5. Click the More button and click **Make Host** menu

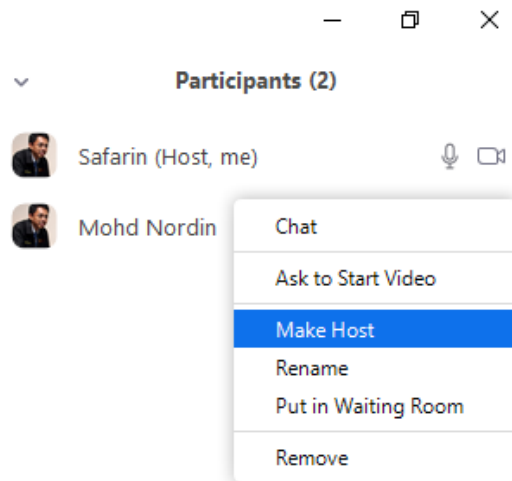

6. Use the **Invitation URL** or **Participant ID** to invite your students via email, WhatsApp & etc.
7. You can Record your meeting by clicking the Record Button at the bottom of your zoom screen.

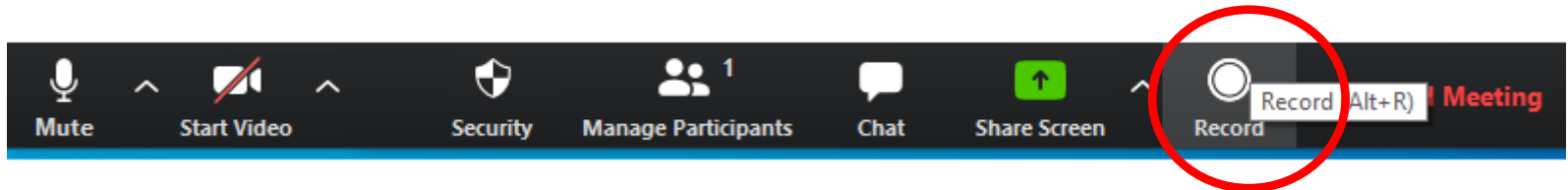

Online teaching starts with

- Attendance
- Welcome student
- Ask student about internet reception/signal
- Recall the last lesson



The screenshot displays a Zoom meeting interface. At the top left is the UTM logo. The top right shows the host's name: DR. MOHD SAFARIN BIN NORDIN. The main area features a large QR code with the UTM SMART logo in the center. To the left of the QR code is a list of participants with their names and join times:

- FARIZALMI BIN JUHARI 02:27:06 PM
- AISYAH BINTI YAKOP 02:27:03 PM
- MUHAMAD ASYRAF BIN YAHYA 02:24:23 PM
- NUR SYAMIMI BINTI AHMAD 02:24:18 PM
- AHMAD FARHAN BIN SHAI PUDDIN 02:24:16 PM

Below the list, it shows "Attendance : 11 / 17" and a "Deactivate QR code" button. A meeting control panel on the right shows a grid of video thumbnails for participants: Mohd Safa... (Host...), Azfar Haiqal, Farizalmi Juhari, and Ahmad Farhan. Below this is a "Participants (15)" list with a search bar and names: Farizalmi Juhari, Hisyam, and Ilya. At the bottom right, there is a small video thumbnail of a participant. A footer text reads "scan the QRCode using UTMSmart app".

New Concept Explanation

2:42 PM 110KB/s

Method of Development

1) Parallel-line development



2) Radial-line development

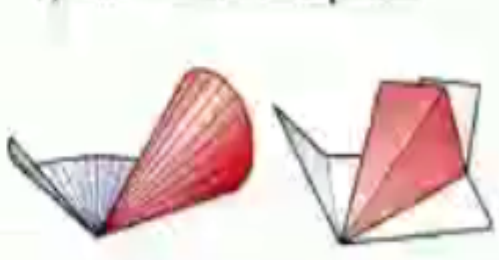

Prisms and single curved surfaces all the edges generation of lateral each other

- It is employed for **Pyramids** and single curved surfaces like **Cones** in which the apex is taken as centre and the slant edge or generator as radius of its development.

3:23

Demonstration Concept Drawing #1

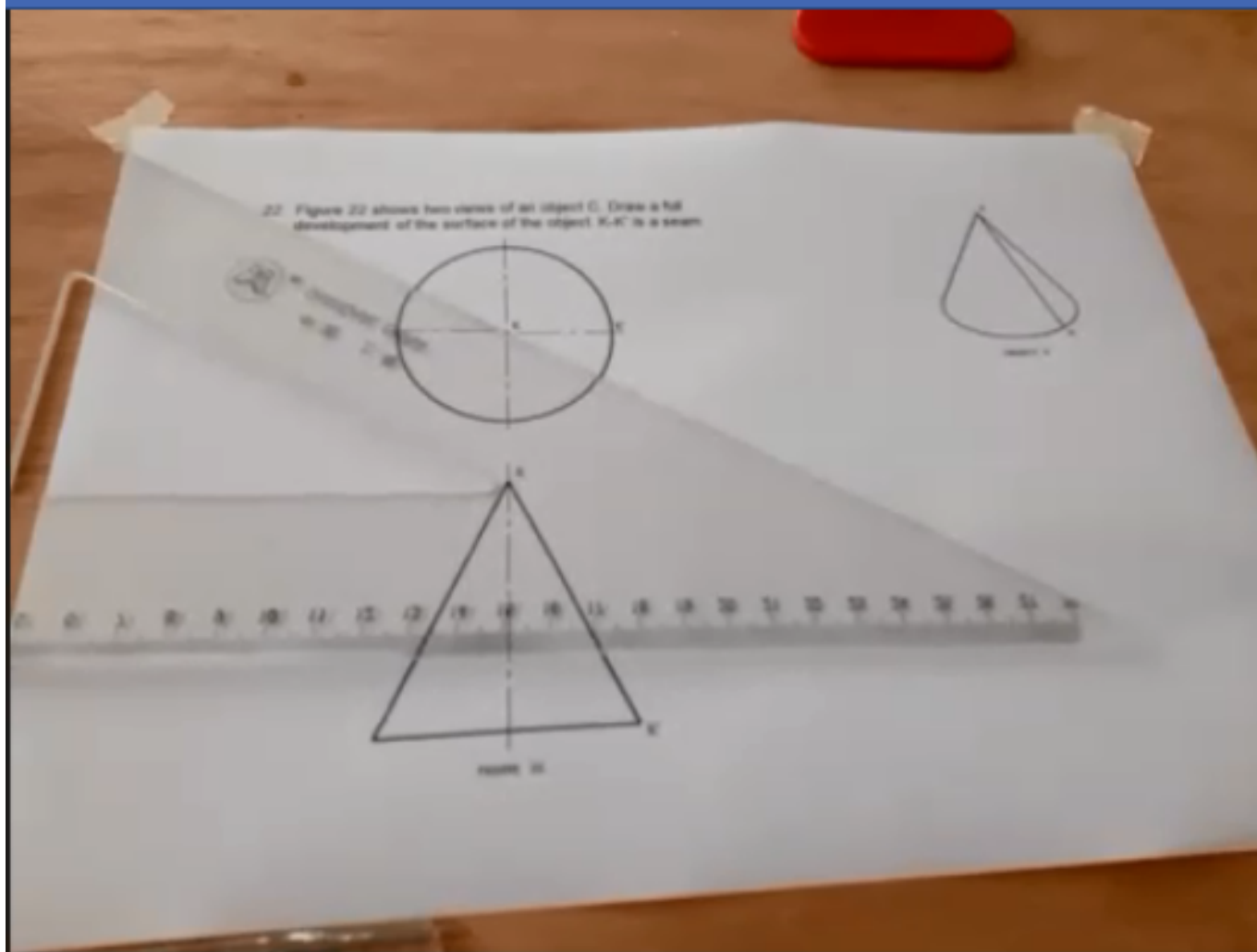

Students Activities

- Imitating the concept drawing step by step within a set time.
- Show on screen and have other students give comment/feedback.

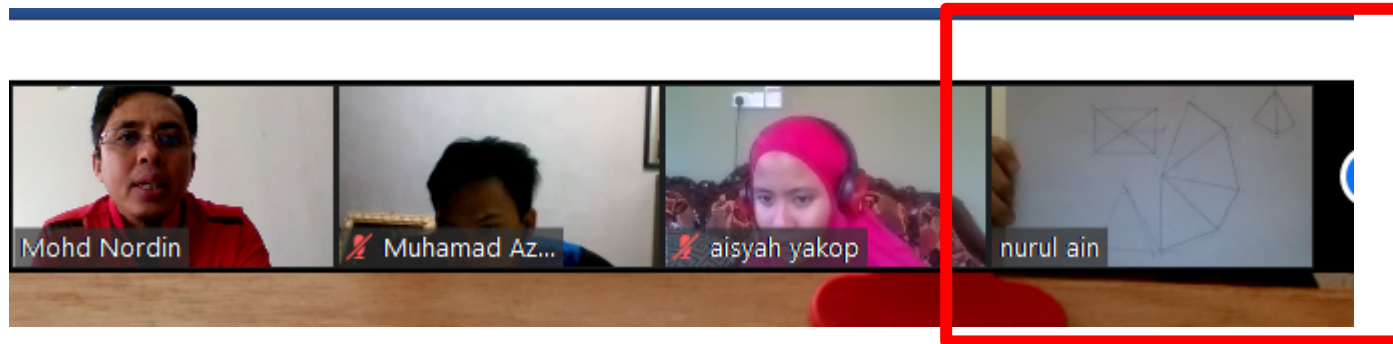

- The online session will last for 10-15 minutes. And students have to draw given a drawing (assignment) applying the newly learned concept.

Demonstration Concept Drawing #2

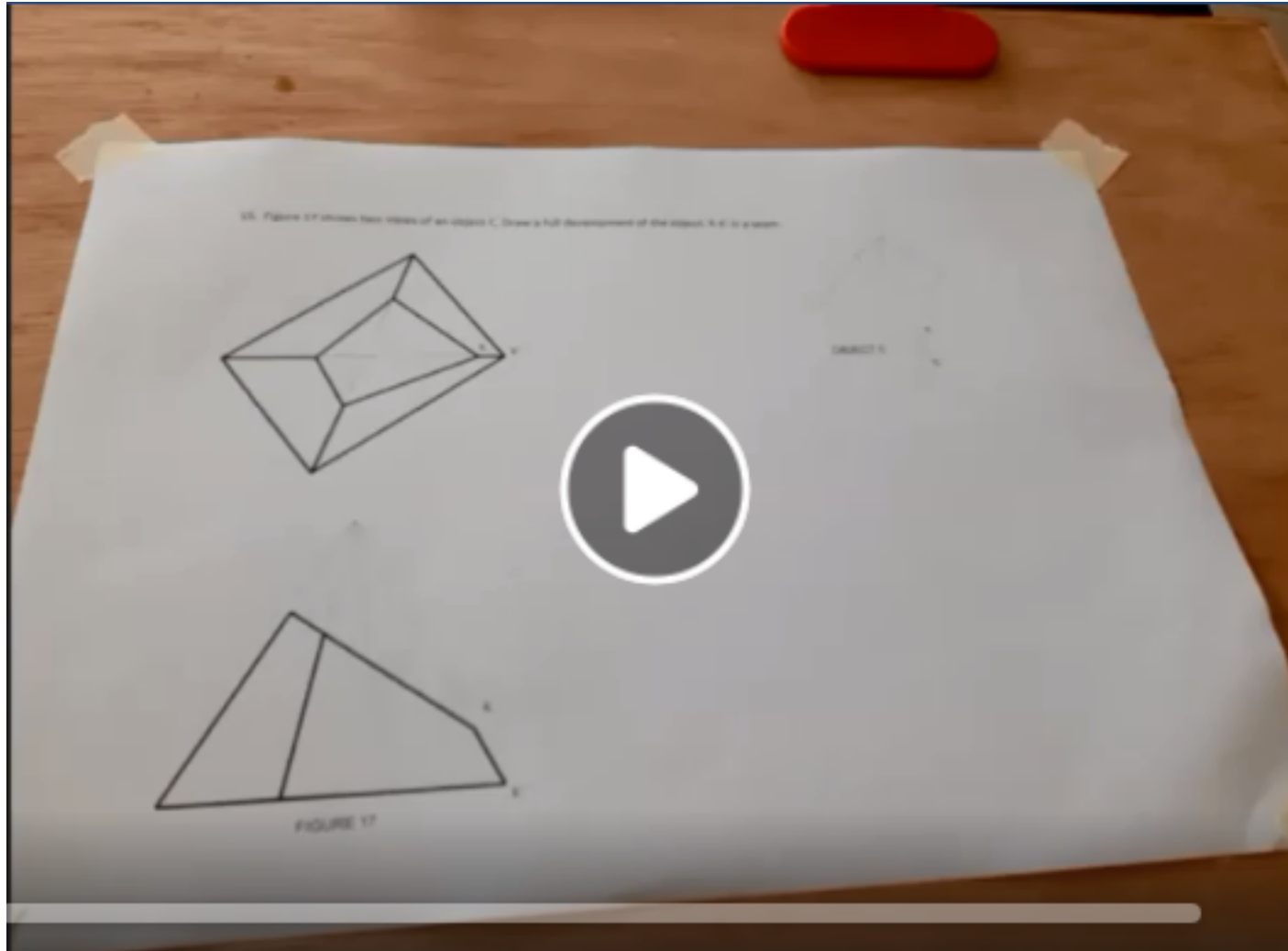

Closing

- Again – Students are asked to copy the concept drawings step by step at a specified time.
- Show on screen and have other students comment/feedback
- Assignments are given to students and they need to submit on a particular date through e-learning.

Student Assignment Submission

The screenshot displays a student's assignment submission process. The background shows a web browser with a course page for 'SHPE1022-02-Latihan Lukisan Pengorakan Kaedah Selari Prisma dan Selinder-75716'. The foreground features a file explorer window showing a ZIP archive named 'SHPE1022-02-Latihan Lukisan Pengorakan Kaedah Selari Prisma dan Selinder-75716 (1).zip' with an unpacked size of 9,581,358 bytes. The file explorer lists 14 image files (JPG) with their respective sizes, packed sizes, and CRC32 values.

Name	Size	Packed	Type	Modified	CRC32
04-11-2020-14.40.03-page-001.jpg	843,558	823,210	JPG File	11/4/2020 3:47 ...	5F5E473F
04-11-2020-14.40.03-page-002.jpg	646,671	609,235	JPG File	11/4/2020 3:48 ...	0A3B87C5
04-11-2020-14.40.03-page-003.jpg	692,580	663,324	JPG File	11/4/2020 3:49 ...	B5444CAF
04-11-2020-14.40.03-page-004.jpg	612,864	576,791	JPG File	11/4/2020 3:49 ...	3846BBFA
04-11-2020-14.40.03-page-005.jpg	790,781	769,631	JPG File	11/4/2020 3:49 ...	2100948D
04-11-2020-14.40.03-page-006.jpg	782,666	754,519	JPG File	11/4/2020 3:49 ...	ACE579F7
04-11-2020-14.40.03-page-007.jpg	724,644	696,327	JPG File	11/4/2020 3:50 ...	58835127
04-11-2020-14.40.03-page-008.jpg	545,888	443,643	JPG File	11/4/2020 3:50 ...	EFCDD90E
04-11-2020-14.40.03-page-009.jpg	575,206	473,978	JPG File	11/4/2020 3:50 ...	F9BC1715
04-11-2020-14.40.03-page-010.jpg	580,454	480,020	JPG File	11/4/2020 3:50 ...	6D611904
04-11-2020-14.40.03-page-011.jpg	596,008	494,849	JPG File	11/4/2020 3:51 ...	6DFEC054
04-11-2020-14.40.03-page-012.jpg	804,781	780,284	JPG File	11/4/2020 3:51 ...	3E2471EF
04-11-2020-14.40.03-page-013.jpg	615,717	516,925	JPG File	11/4/2020 3:51 ...	30542F97
04-11-2020-14.40.03-page-014.jpg	769,540	743,777	JPG File	11/4/2020 3:51 ...	18CBA9A9

Windows taskbar: 5:37 PM, 16/4/2020

Examples of student ED assignments

ARNAD FARHAN BIN SHAI PUDDIN A19HP0007

4. Figure 4 shows two views of an object C. Draw a full development of the object. K-K' is a seam.

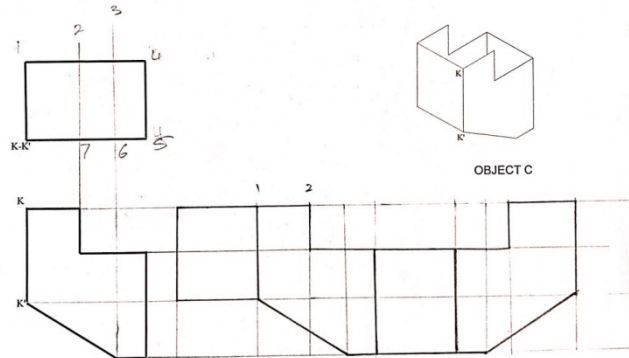
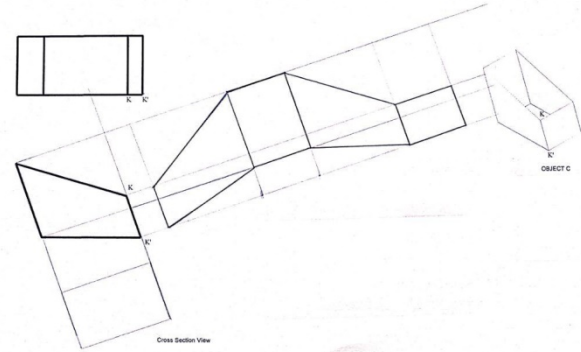

FIGURE 4

Scanned with CamScanner

AGIEL DANIEL BIN MOHD ROSLI A19HP0022

5. Figure 5 shows two views of an object C. Draw a full development of the object. K-K' is a seam.



Cross Section View

ARNAD FARHAN BIN SHAI PUDDIN A19HP0007

10. Figure 11 shows two views of an object C. Draw a full development of the object. K-K' is a seam.

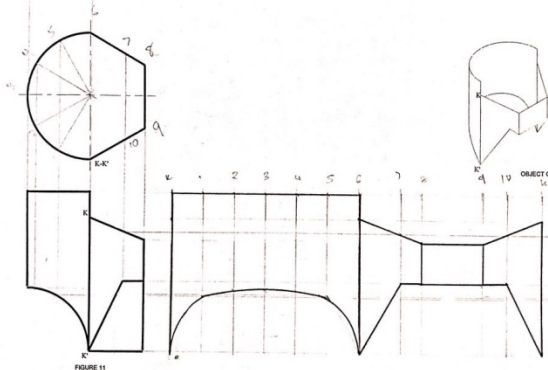
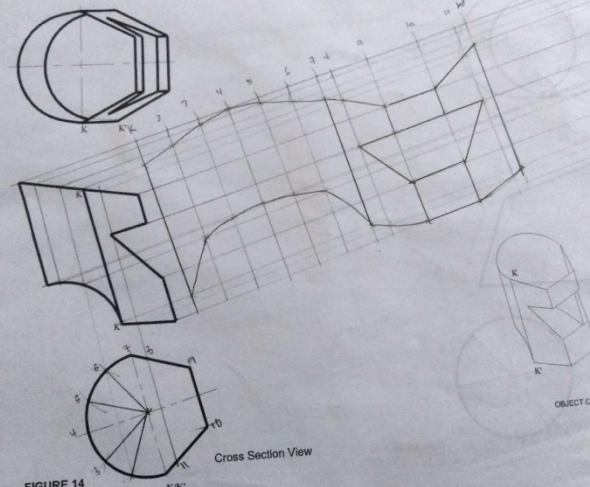

FIGURE 11

Scanned with CamScanner

13. Figure 14 shows two views of an object C. Draw a full development of the object. K-K' is a seam.



Cross Section View

FIGURE 14





**Thank
You!**

A 3D-rendered graphic of a blue sign with the words "Thank You!" in white, bold, sans-serif font. The sign has a slight shadow and is pinned to a white background with a black pushpin at the top center.